

---

# Simulation of the XV-15 Tilt Rotor Research Aircraft

---

Gary B. Churchill and Daniel C. Dugan

---

March 1982





---

# Simulation of the XV-15 Tilt Rotor Research Aircraft

---

Gary B. Churchill, U.S. Army Aeromechanics Laboratory, Moffett Field, California  
Daniel C. Dugan, Ames Research Center, Moffett Field, California



National Aeronautics and  
Space Administration

**Ames Research Center**  
Moffett Field, California 94035

United States Army  
Aviation Research  
and Development  
Command





# SIMULATION OF THE XV-15 TILT ROTOR RESEARCH AIRCRAFT

Gary B. Churchill\*  
U. S. Army Aeromechanics Laboratory  
Moffett Field, California

and

Daniel C. Dugan†  
Ames Research Center, NASA  
Moffett Field, California

## Abstract

The XV-15 Tilt Rotor Research Aircraft Program (TRRA) exemplifies the effective use of simulation from issuance of the request for proposal through conduct of a flight test program. From program inception, simulation complemented all phases of XV-15 development. The initial simulation evaluations during the source evaluation board proceedings contributed significantly to performance and stability and control evaluations. Eight subsequent simulation periods provided major contributions in the areas of control concepts, cockpit configuration, handling qualities, pilot workload, failure effects and recovery procedures, and flight boundary problems and recovery procedures. The fidelity of the simulation also made it a valuable pilot training aid, as well as a suitable tool for military and civil mission evaluations. Recent simulation periods have provided valuable design data for refinement of automatic flight control systems. Throughout the program, fidelity has been a prime issue and has resulted in unique data and methods for fidelity evaluation which are presented and discussed.

## Introduction

The XV-15 Tilt Rotor Research Aircraft program is a joint Army/NASA/Navy program initiated in 1973

\*Handling Qualities, Flight Controls, and Simulation Specialist, Tilt Rotor Research Aircraft Project.  
†XV-15 Project Test Pilot.

as a "proof-of-concept" and "technology demonstrator" program for the tilt rotor V/STOL aircraft concept (Navy participation began in 1979). Two aircraft were built by Bell Helicopter Textron, and basic proof-of-concept flight testing was completed in September 1981. At present, one aircraft is at Ames Research Center for continuation of government flight testing for aircraft documentation, and the other is at Bell Helicopter Textron for further contractor development and participation in military applications demonstrations. Significant program milestones are shown in Fig. 1.

The tilt-rotor concept is relatively complex and, based on other V/STOL aircraft history, was considered to be a high-risk program. Therefore, from program conception, comprehensive piloted simulation was made an integral part of the design, development, and test programs. Starting with parallel simulation of the bidders' design proposals, and continuing through October 1981, simulation was integrated with the entire flight test program. Before first hover tests of the XV-15 in May 1977, four major simulations and one limited simulation were conducted at Ames Research Center. The major simulations utilized the Flight Simulator for Advanced Aircraft (FSAA), and the limited hover simulation was performed on the Six-Degree-of-Freedom simulator. Since the beginning of the contractor's flight test program in April 1979, four additional major simulations have been performed to investigate flight-test anomalies, systems refinement, and military missions evaluations. Three utilized the FSAA, and one utilized the new Vertical Motion Simulator (VMS). These simulation periods were also used to provide pilot training and

• CONTRACT SIGNED	JULY 1973
• NO. 1 XV-15 ROLLOUT	OCTOBER 1976
• GROUND TIE-DOWN TESTING	JANUARY-MAY 1977
• HOVER TESTS (AIRCRAFT NO. 1)	MAY 1977
• WIND TUNNEL TESTS (AIRCRAFT NO. 1)	MAY-JUNE 1978
• CONTRACTOR FLIGHT TESTS (NO. 2)	APRIL 1979-JULY 1980
• GOVERNMENT ACCEPTANCE (NO. 2)	OCTOBER 1980
• GOVERNMENT FLIGHT TEST	JANUARY 1981-CONTINUING
• PARIS AIR SHOW (NO. 1)	JUNE 1981
• CONTRACTOR DEVELOPMENT (NO. 1)	OCTOBER 1981-CONTINUING

Fig. 1 XV-15 aircraft program chronology.

familiarization in addition to satisfying the research objectives.

Since the piloted simulation efforts were considered to be a critical element of the program, the overall fidelity of the simulation was of prime importance. The required fidelity was obtained by close attention to mathematical model integrity, as well as to fidelity issues related to normal simulation problems. These included motion and visual systems and correlation with actual flight characteristics of the aircraft. This report presents the manner in which the XV-15 simulation was developed to provide the required fidelity, its use throughout the program, its limitations, and an assessment of its value relative to program performance and safety.

XV-15 Design Characteristics

A brief description of the XV-15 tilt rotor will help to define the scope and complexities of the simulation model. The aircraft hovers and operates in low-speed flight as a lateral-tandem-rotor helicopter, with that vehicle's attendant stability and control requirements (Fig. 2).

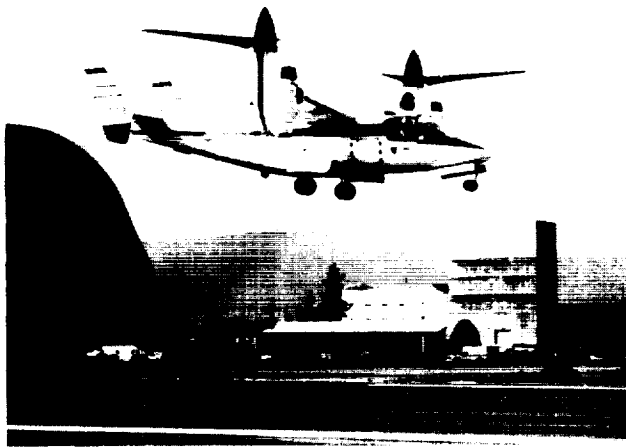

Fig. 2 XV-15 in helicopter mode.

It also flies as a high-performance, turboprop airplane with conventional control surfaces (Fig. 3).

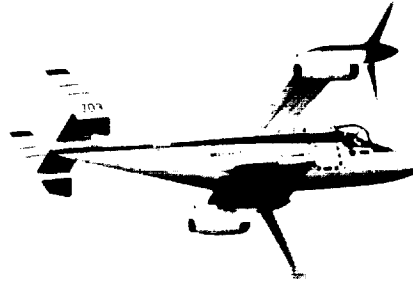

Fig. 3 XV-15 in airplane mode.

In between modes, it uses a combination of rotor and conventional airplane controls, for it derives lift from both the rotors and the wing. Control phasing is accomplished mechanically with control-system gains varying with nacelle tilt and airspeed.

The XV-15 is powered by two Lycoming T-53 turboshaft engines, designated LTC1K-4K, which are rated at 1,550 shp for takeoff with a normal rating of 1,250 shp. A transmission cross-shaft permits both rotors to be driven by one engine. The engines, transmissions, and rotor systems are located in wing-tip nacelles which can be rotated 95°—from 0° in the airplane mode to 5° aft of vertical in the helicopter mode. The three-blade proprotors are 25 ft in diameter and the blade twist is 45° from root to tip. They are gimbal-mounted to the hub with an elastomeric spring for control augmentation. The wing span is 32 ft from spinner to spinner, and the aircraft is 42 ft long (Fig. 4). Wing loading is 77 lb/ft<sup>2</sup>, and disc loading at the design gross weight of 13,000 lb is 13.2 lb/ft<sup>2</sup>. The XV-15 carries 1,475 lb of fuel, which allows a research flight of about 1 hr. It is equipped with LW-3B rocket seats for the crew of two.

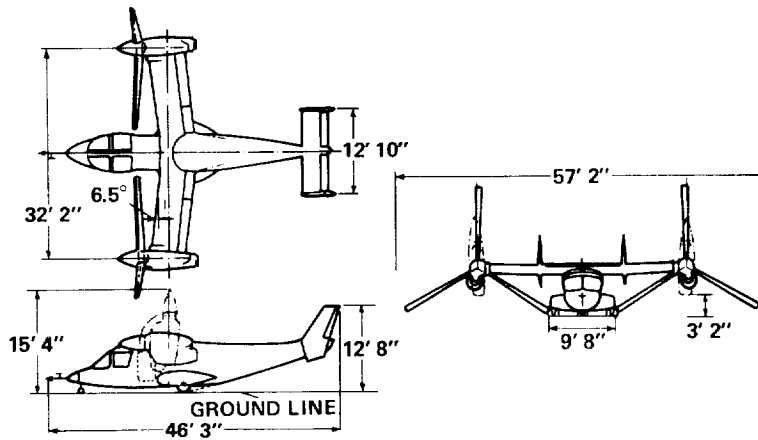

Fig. 4 XV-15 dimensions.

In the helicopter mode, the XV-15 flight control system can be compared to that of a lateral-tandem helicopter. The use of collective pitch, cyclic pitch, differential cyclic, and differential collective are shown in Fig. 5. During hovering flight, the airplane control surfaces are active but are ineffective at low speeds. Rotor controls are mechanically phased out as the conversion process progresses to the airplane mode and the conventional elevator, flaperons, and rudders

generate control moments. Full-span, electrically operated flaps are used during hover and in the conversion modes. A schematic of the flight-control system is presented in Fig. 6.

Rotor rpm is maintained by a blade-pitch governor, which detects error between commanded and actual rpm. Collective-pitch inputs from the dual-channel governor are superimposed on collective-pitch inputs from the power lever and lateral stick

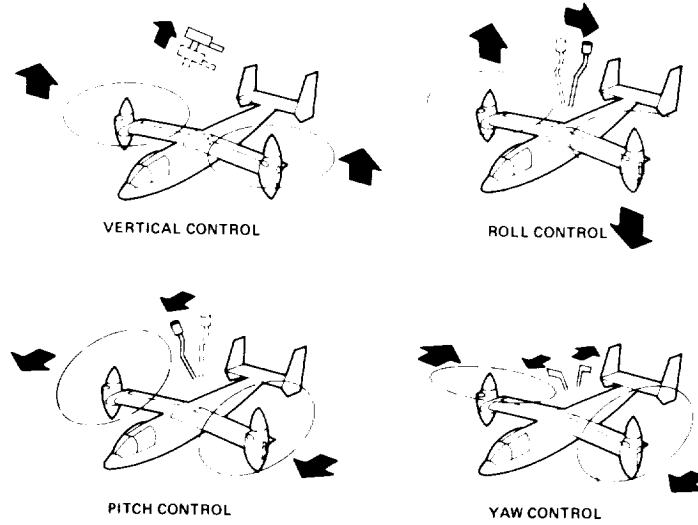

Fig. 5 Helicopter mode control functions.

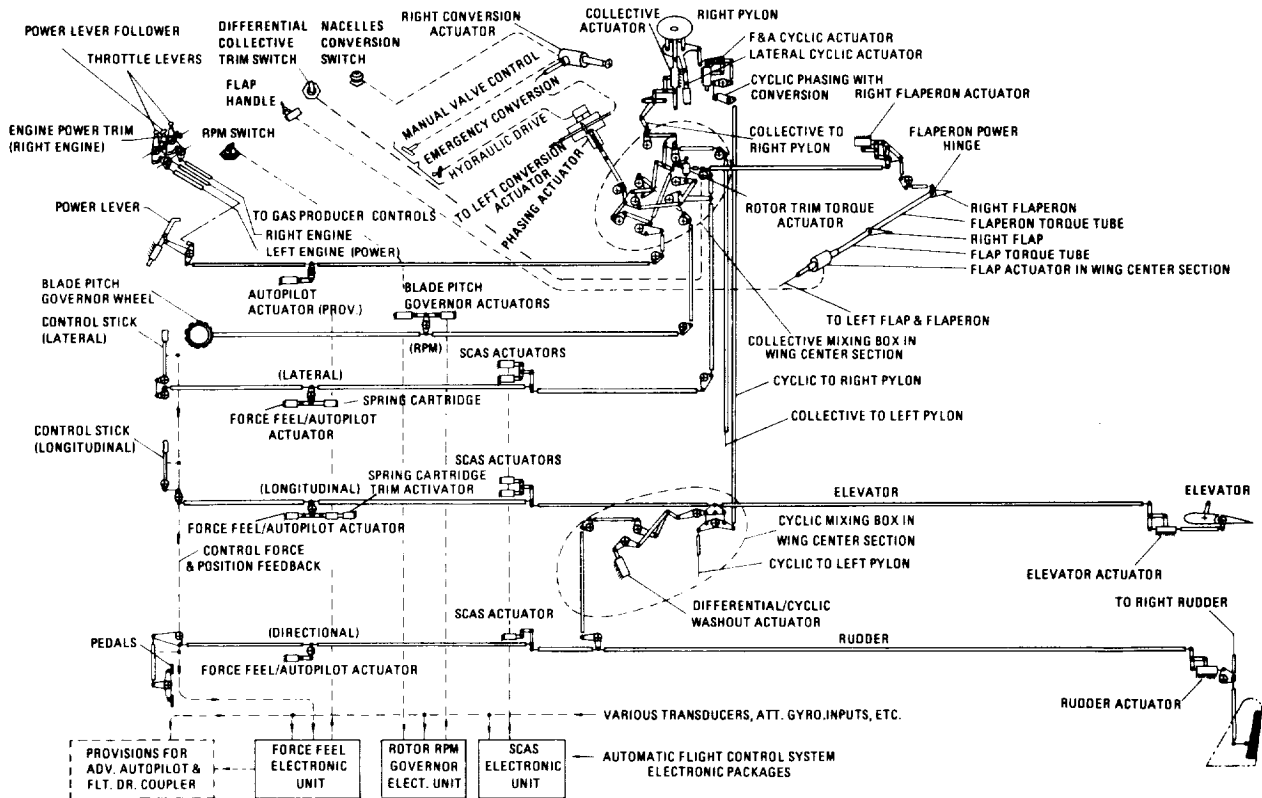

Fig. 6 Flight control system schematic.

301001-2

in the helicopter mode. Total collective-pitch authority is transferred to the governor during conversion to airplane mode. A manual control wheel in the cockpit may be used for rpm control should the governor fail.

Stability and control augmentation (SCAS) is provided by a three-axis rate system with a pitch and roll attitude retention feature. SCAS gains are varied with conversion angle to provide appropriate rate damping and control augmentation for either helicopter or airplane mode flight. Pitch and roll axes have dual channels, and the yaw axis is single channel. SCAS-off flight has been routinely demonstrated; damping and control are degraded, but the XV-15 is quite safe to fly, even though the pilot workload is significantly higher. A force-feel system (FFS) provides stick and pedal forces proportional to control displacements while isolating the pilot controls from SCAS feedback forces. Force gradients are increased and trim rates are decreased with airspeed through a dynamic pressure ("q") sensor. With FFS off, pitch trim is available at a reduced rate; control forces are high but manageable.

An interconnected, hydraulically powered conversion system (Fig. 7) provides 95° of nacelle tilt at a rate of approximately 7.5°/sec. A continuous conversion can be accomplished in about 12 sec, or the pilot can perform the conversion in steps or at a slower rate of 1.5°/sec. Hydraulic power for conversion is triply redundant because the XV-15 cannot be landed in the airplane mode. In the event of total electrical failure, the pilot still has mechanical access to hydraulic power to convert to the helicopter or STOL mode.

The current airspeed-altitude envelope is shown in Fig. 8. Some of the level-flight stabilized points are plotted along with the predicted envelope based on the normal rated power and torque limits.

Additional details of the XV-15 design are given in Refs. 1 through 4.

## Simulation Description

The simulation facilities at Ames Research Center are designed to provide research simulation capability for a wide variety of aircraft concepts, ranging from helicopters and V/STOL aircraft to supersonic transports and the Space Shuttle. These facilities are operated and maintained by the Flight Systems and Simulation Research Division of the Aeronautics and Flight Systems Directorate. The active time required for any one simulation on a major facility (FSAA or VMS) varies from several weeks to several months. Figure 9 presents a schematic of the simulation system applicable to any desired configuration.

The elements common to all simulations are the cab and motion system, the visual systems, control loaders, and a host computer, in this case, a Xerox Data Systems (XDS) Sigma 8. Within the host computer, standard software is provided for all equations of motion, transformations, motion and visual drives, etc. The user provides the mathematical model for the aircraft, including all aerodynamics, structural dynamics (if included), flight controls, instrument requirements, and definitions of force-feel system parameters.<sup>5</sup> When done in this manner, a change in configuration from simulation to simulation only requires changing the simulator cab instrument panel and control configuration to that required by the user, installing and checking out the user's mathematical model on the computer, and integrating the desired elements into an operating system. These changes are normally accomplished in about 2 weeks; this includes generating fidelity evaluation data as required by the users. These data normally include such items as static and dynamic checks, visual, force-feel, and motion systems frequency response data, or any other data specified by the user. The evaluations and data requirements used to assess the XV-15 simulation fidelity will be discussed later.

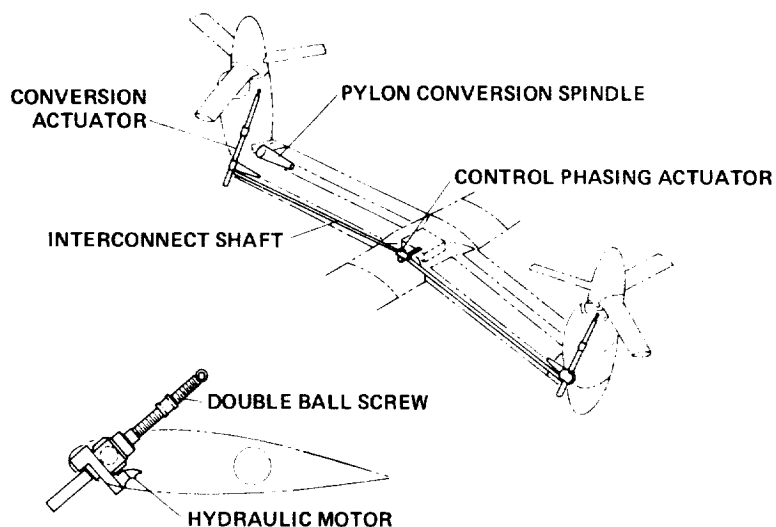

Fig. 7 Conversion system.



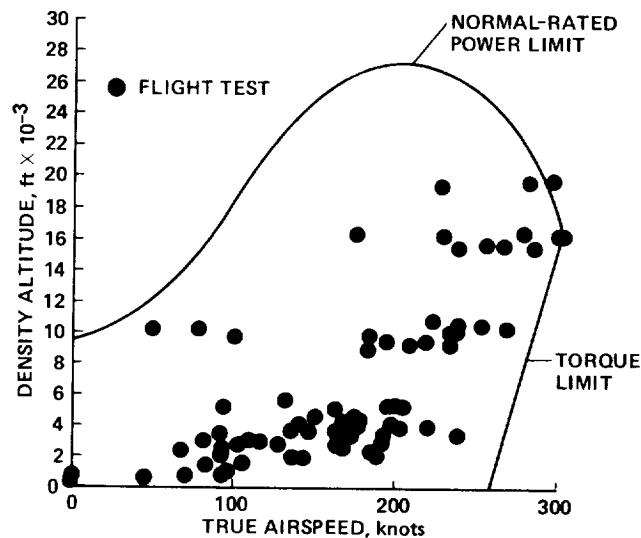

Fig. 8 Airspeed-altitude envelope.

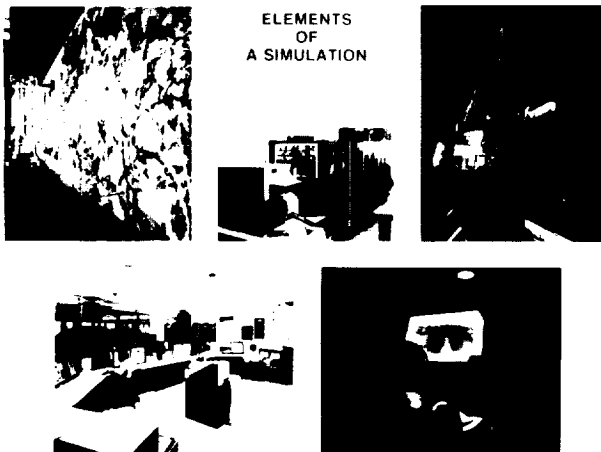

Fig. 9 Simulation elements.

#### Development

The decision to make piloted simulation a significant and integral part of the Tilt Rotor Research Aircraft (TRRA) program was made in July 1971, before TRRA program approval by NASA and Army Headquarters. The requests for proposals for the mathematical model and simulation development were released in August 1971, with the following ground rules for bidders:

- 1) A complete nonlinear mathematical model and aircraft simulation was to be developed
- 2) Modular mathematical model construction in a specified format was to be used
- 3) The mathematical model was to be programmed and checked out at the contractor's facility, simultaneously with programming and check out at the government's facility (FSAA)
- 4) The simulation was to be operational on the FSAA in 1 year

Two bidders responded to the request for proposals, Boeing-Vertol and Bell Helicopter Textron (BHT), who were also the only subsequent bidders for the aircraft development.

Although this program was extremely ambitious, both contractors completed their efforts in about 14 months, which was in time to effectively use the simulation during the source evaluation board (SEB) proceedings in March 1973. Both the contractors and the government obtained significant benefits from the simulation development program. The contractors developed an "in-house" simulation for their use in proposal preparation, and the government received a program from each contractor. These programs provided both the contractor's data and analytical methods for evaluating the contractors' performance, and stability and control proposal submittals.

#### Mathematical Model

A detailed discussion of the XV-15 mathematical model<sup>6</sup> is beyond the scope of this paper. At the time it was developed, it was the largest, most complex ever implemented on the simulation facilities at Ames Research Center. It contains a complete nonlinear representation of the XV-15 aircraft, which includes all aerodynamics through an angle of attack and sideslip range of  $\pm 180^\circ$ , interactions of the rotor wake on the airframe, all flight controls and actuators, the automatic flight controls and the landing gear. The rotor model uses linearized aerodynamics with nonuniform inflow rather than strip analysis, since the latter requires more computer capacity than is available. The rotor model is valid for the full XV-15 envelope, including autorotations. Additional details on nonlinear complex aerodynamic interactions are available in Ref. 7. The total model represents 13 degrees of freedom. Since program inception, the mathematical model document has undergone eight revisions to maintain its status relative to the aircraft configuration and data base. The latest revision was completed in 1980 and represents the present aircraft configuration.

The requirement for a modular structure of the mathematical model was specified to streamline the general programming and to provide simple access to any particular module for changes resulting from variations in the design or from improvements in the data bases. Thus, although each module had a fixed input and output, the modeling within the module could be simplistic initially and increased in complexity as analysis or data justified. The final configuration of the mathematical model<sup>6</sup> contains 20 separate subsystems or modules.

During the early phases of the XV-15 program, Systems Technology, Inc. (STI), Hawthorne, California, provided technical support to the Project Office in the areas of flight controls development and simulation. As a result of these efforts, STI developed an addendum for the BHT mathematical model which provided the additional capability of evaluating the effects of control-system hysteresis and flexibility on aircraft characteristics.<sup>8</sup> This modeling could be switched in or out for evaluations, and was quite valuable in identifying limit-cycling behavior occurring during flight test. The effect of the hysteresis modeling on simulation is discussed in the section on fidelity.

The mathematical model of the XV-15 landing gear was the only significant aircraft element that was compromised in the simulation. This was because the digital simulation cycle times required were far in excess of that required for the high rate of change of forces on the landing gear during touchdown. This problem is also discussed further in the section on fidelity.

A significant portion of the simulation use was devoted to identifying failure effects and recovery procedures, since significant adverse failure effects could require systems redesign. To facilitate these evaluations, systems failures were modeled for single or dual engines, hydraulic systems, electrical systems, stability and control augmentation systems, force-feel systems, and governor systems. These are controlled by the test engineer and are currently used during training and familiarization of new pilots.

The effects of airframe aeroelastics were considered in the contractor development phase by Boeing-Vertol. The modes evaluated were wing vertical bending (3.5 Hz), wing torsion (10 Hz), and wing chord bending (6 Hz). These were evaluated on the contractor's simulation facility, where it was determined that the only mode affecting the pilot control task was wing vertical bending. This occurred only in hovering flight, and the net effect was to cause an approximate 0.1-sec lag in vertical response to control. Since this lag is approximately the same as that induced by digital simulation cycle-time lag, further considerations of aeroelastics were deleted.

#### Simulation Hardware

During the course of the XV-15 program, three of the simulators at Ames Research Center were used: the Flight Simulator for Advanced Aircraft (FSAA), the Vertical Motion Simulator (VMS), and the Six-Degree-of-Freedom Motion Simulator (6-DOF). The FSAA and VMS simulations were essentially identical, with the exception of the motion systems. The 6-DOF simulation utilized a simplified

perturbation-type mathematical model applicable only to hover and low-speed flight (0-10 knots).

Flight Simulator for Advanced Aircraft. The FSAA has been the workhorse of the XV-15 simulation program (Fig. 10). It permitted large-amplitude motion and rapid accelerations for the many tasks and evaluations performed. The cab is provided with a virtual image television visual which presents a visual scene from one of two large terrain boards. These boards provided a typical airport and runway environment, a STOL port, carrier or other ship models for landing, a nap-of-the-earth terrain area for low-level flight around vegetation and hills, and other features to enhance the realism of the simulation. Provisions for instrument flight to minimums were available, as well as flight "on top" to escape the confines of the terrain-board boundaries. Other aids to the pilot include a Visual Approach Slope Indicator (VASI) light for approaches to the runway. An XDS Sigma 8 digital computer was used to compute the aircraft dynamics. Electro-hydraulic control loaders were used to provide the variable stick and pedal control forces necessary for the simulation. The right side of the two-place cab was set up for the XV-15 with essential controls and instruments. Details of the cockpit will be discussed later.

Vertical Motion Simulator. The VMS was used to examine SCAS and blade-pitch governor modifications designed to improve the response and handling qualities of the XV-15. It is a new and unique simulation facility which includes the capability for 60 ft of vertical motion and 40 ft of lateral travel (Fig. 11). The visual systems, control loaders, and computers used are essentially the same as those used during FSAA simulations.

The Six-Degree-of-Freedom Motion Simulator. The 6-DOF simulator has a single-place cab and is well suited for the evaluation of VTOL aircraft in hovering flight (Fig. 12). Helicopter controls were used for this limited evaluation, and the cockpit was left open to provide a one-to-one visual simulation, using the interior of the facility and the world outside through open hangar doors. The motion system was driven directly from computed aircraft accelerations (no washouts were employed). Therefore, within an 18-ft cube all attitude, motion, and visual cues were real. An early look at some failure modes was accomplished and an automatic system to increase engine power in the event of single-engine failure during hover was eliminated from the design. In all cases, the pilots beat the automatic system with power application.

XV-15 Simulated Cockpit. The cockpit setup for the XV-15 simulations provided the pilots with the essential controls and instruments to effectively simulate the aircraft. The instrument panel of the simulator is shown in Fig. 13 and that of the XV-15 is shown in Fig. 14. The cockpit configuration was identical for both the FSAA and VMS simulations. The instruments, although not identical to those in the aircraft in most cases, were similar and their locations in the simulator closely matched their locations in the XV-15. Many engine, transmission, and systems gages and the caution panel were not functional but only mocked-up in the simulator. The center console of the simulator, partially shown in Fig. 13, incorporated SCAS, FFS, and governor panels which were identical in function and very similar in appearance to the real thing.

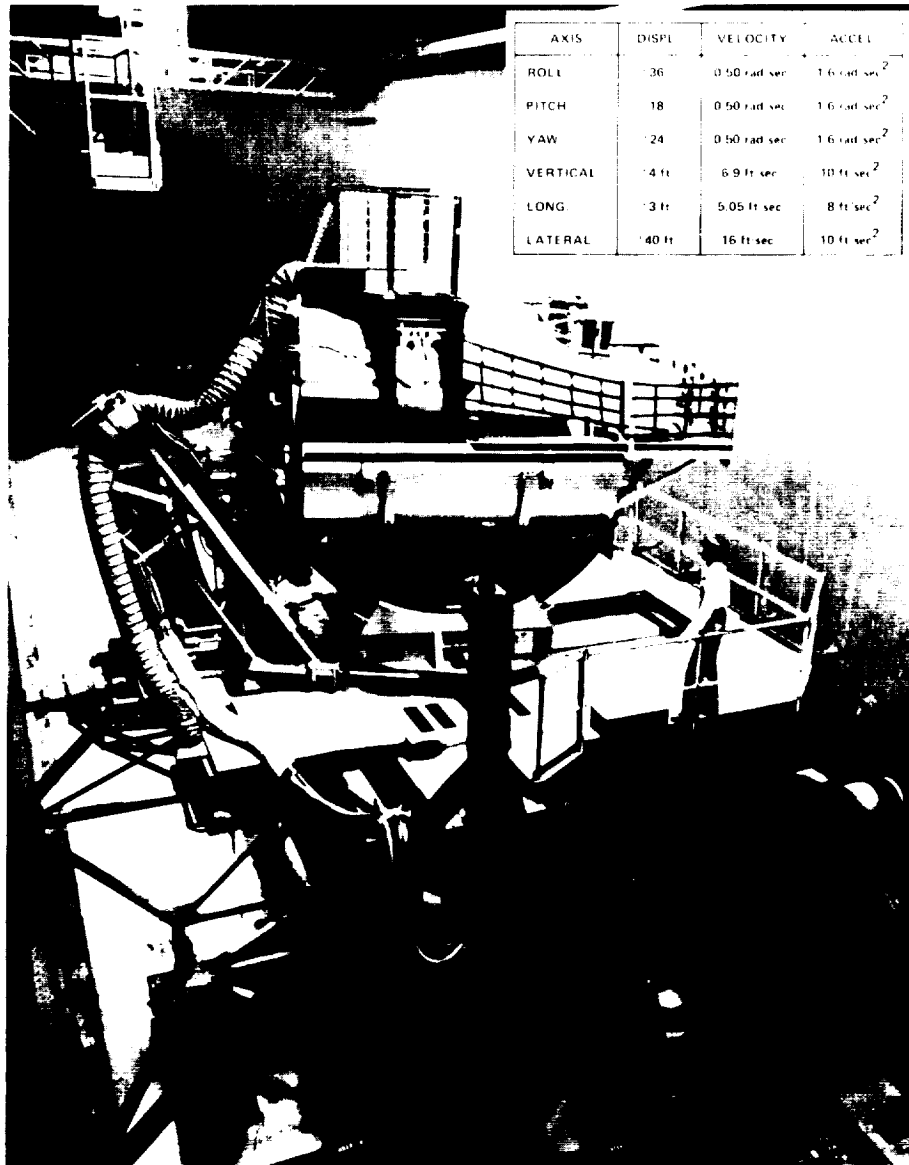

Fig. 10 Flight Simulator for Advanced Aircraft.

The power lever and control stick in the simulator were configured to match those in the XV-15, and they incorporated the same functions and switches in their design. Finally, the landing gear and flap switches were located on the right, aft end of the center console in their proper location. All of this attention to detail was important in the research simulator. This was not only true for the evaluations of the aircraft response and handling qualities, but also for the transfer of training, both deliberate and unplanned, which the pilots would acquire during the simulations before the first flight of the aircraft. Instrument scan, control feel and manipulation, and systems operation during normal operation and failure modes had to be realistic.

#### Simulation Evaluations

##### Chronology

The XV-15 simulation chronology is shown in Fig. 15. The initial XV-15 simulation in 1973, conducted on the FSAA, was a comparative evaluation of the two contractors' design proposals for a tilt-rotor aircraft. NASA, Army, and contractor pilots and engineers participated in the evaluation, and the results were considered in "other factors" in the source evaluation process. After the selection of the contractor to build the two tilt-rotor aircraft in July 1973, a limited simulation was conducted on the 6-DOF simulator for some early design analysis. It was followed in December 1973 by an

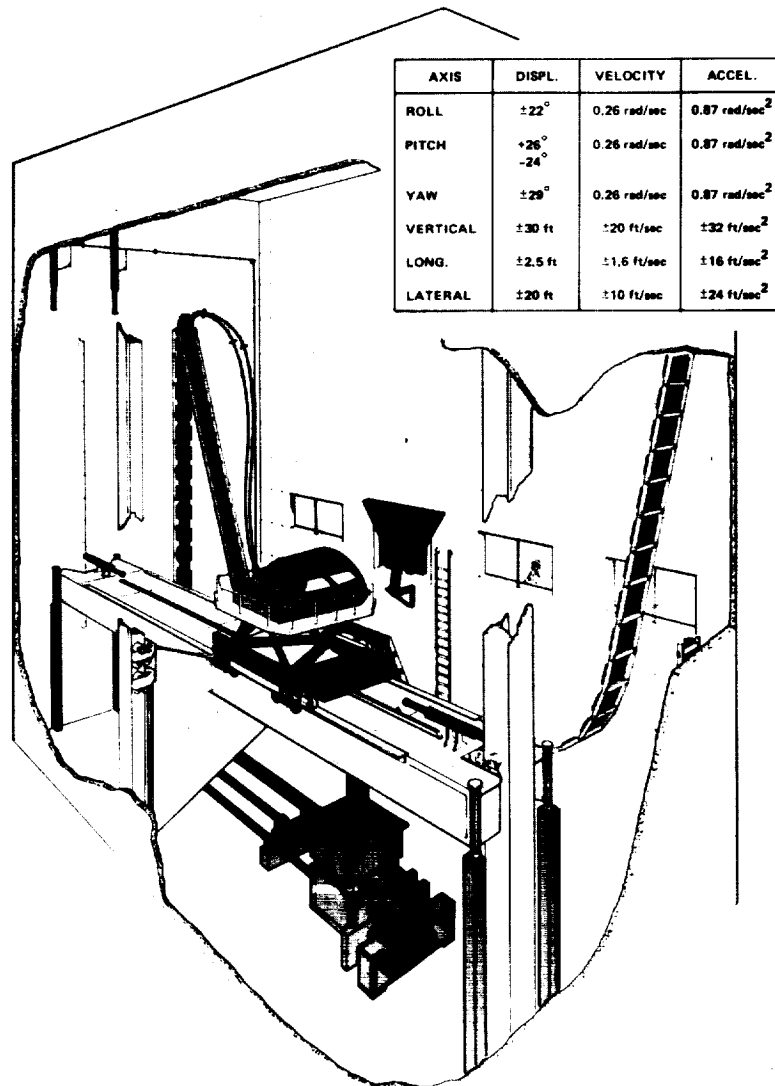

Fig. 11 Vertical Motion Simulator.

extensive simulation on the FSAA of the selected Bell configuration.<sup>9</sup> The simulation covered control-system and subsystem engineering studies, aircraft handling-qualities investigation, and the cockpit design.

Significant control-system and mathematical model changes resulted from this effort. It was followed in July of 1974 by another major simulation to continue design analysis of the control system and subsystems in normal and failure modes and investigation of predicted handling qualities.<sup>10</sup> Cockpit layout evaluations continued and changes were incorporated. In October 1975 the simulation objectives were to investigate various operational conditions and to look at envelope boundary or

limit conditions.<sup>11</sup> Cockpit changes made since the last simulation were also evaluated. Flight boundary conditions included thrust and blade-load limits and wing stall. This completed program-related simulation activity prior to the rollout and first hover flights of the XV-15. The mathematical model continued to be used for advanced tilt-rotor applications. Investigations of control, guidance, and display concepts<sup>12</sup> were conducted, as well as military applications and missions with advanced control configurations.

After the initial hover tests, the XV-15 was tested extensively in the Ames 40- by 80-Foot Wind Tunnel in 1978. These tests were preceded by off-line simulation of aircraft failures predicted to

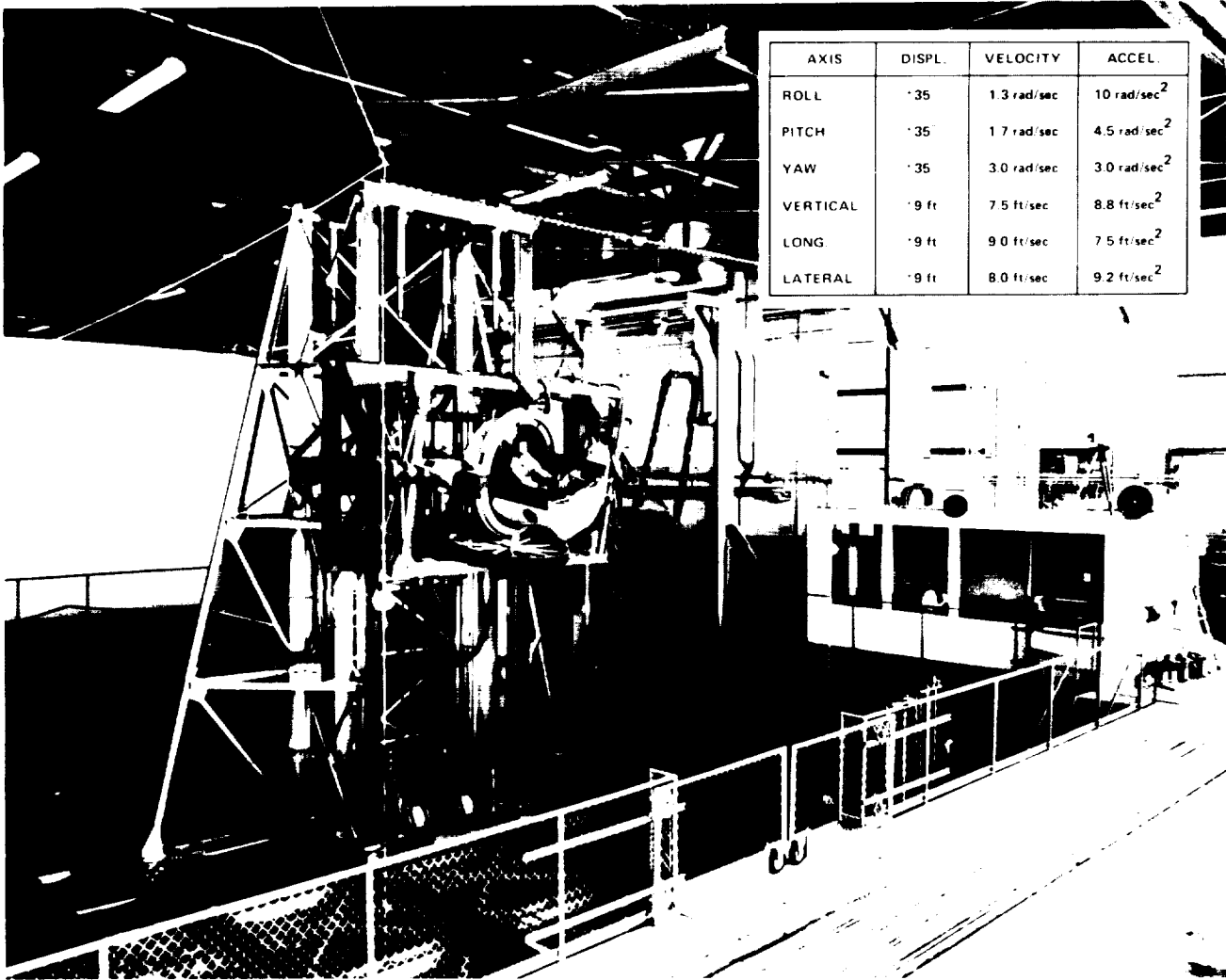

Fig. 12 Six-Degree-of-Freedom Motion Simulator.

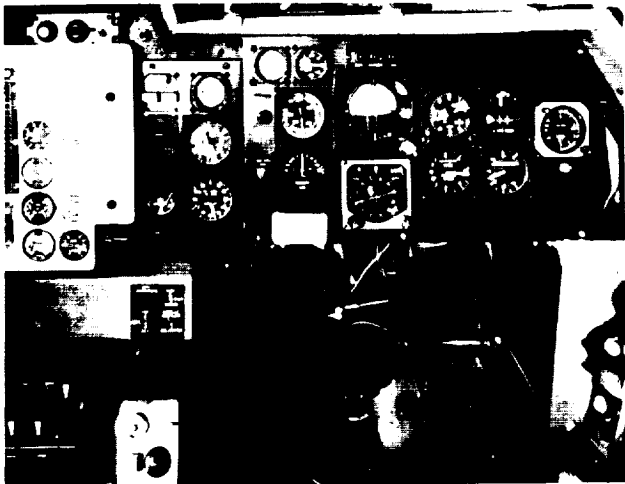

Fig. 13 XV-15 simulator instrument panel.

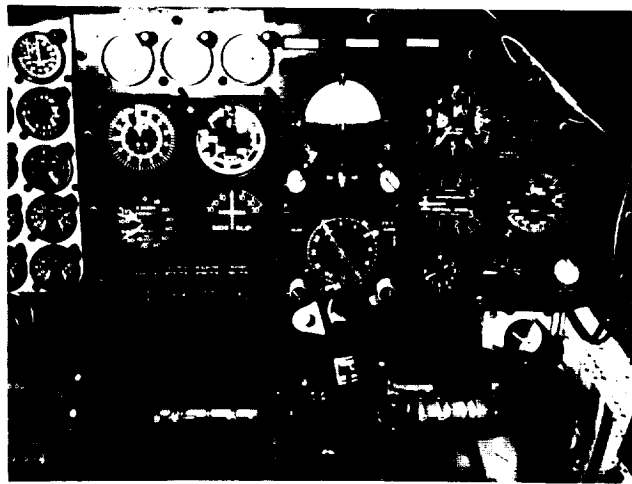

Fig. 14 XV-15 aircraft instrument panel.

● SIMULATION OF CONTRACTOR PROPOSALS	MARCH 1973
● LIMITED DESIGN EVALUATION	OCTOBER 1973
● SIMULATION OF SELECTED CONFIGURATION	DECEMBER 1973
● CONTROL SYSTEM AND HANDLING QUALITIES	JULY 1974
● OPERATIONAL AND BOUNDARY CONDITIONS	OCTOBER 1975
● MILITARY MISSIONS AND PILOT FAMILIARIZATION	MARCH 1980
● SCAS AND GOVERNOR MODIFICATIONS	OCTOBER 1980
● SCAS AND GOVERNOR MODIFICATIONS	MARCH 1981
● UNTESTED MODIFICATIONS AND CONFIGURATIONS	OCTOBER 1981

Fig. 15 Aircraft simulation chronology.

be critical during wind tunnel testing. This was done to identify potentially dangerous conditions and to develop recovery procedures. Additional moving-base simulations were conducted at Ames Research Center after the start of the contractor flight test program in April 1979. The first of these,<sup>13</sup> conducted in early 1980, had pilot familiarization as a primary objective along with limited evaluation of military missions. The next period, in the fall of 1980, was devoted primarily to control-system modification evaluations. It was conducted on the newly activated Vertical Motion Simulator at Ames while one XV-15 was being flight tested at the Dryden Flight Research Center, Edwards AFB, California. SCAS and governor modifications were evaluated and later tested in the aircraft. The following simulation, early in 1981, also involved SCAS and governor refinements. Finally, the most recent simulation activity at Ames was run on the FSAA in the fall of 1981 while both XV-15 aircraft were on flight-test status at Ames. In addition to future modifications and configurations, some simulation validation was accomplished.

An additional nonpiloted use of the simulation was the development of a parameter identification algorithm for use in stability and control flight testing.<sup>13</sup> The aircraft stability derivatives and response-time histories for various flight conditions were developed on the simulator. The time histories were then processed to obtain the derivatives via the parameter identification algorithm. The results are encouraging, and it is intended that the procedure will be used during the government flight-test program.

#### Accomplishments

During 9 years of XV-15 simulation, the primary program objectives were met. After the development of the detailed mathematical model, a valuable research tool was available to the design engineers and pilots involved in the aircraft development. Before flight of the aircraft, detailed design studies and analyses on the simulator resulted in major improvements to the XV-15 configuration and control system. Piloted evaluations permitted the optimization of control-system gains, the early investigation of failure modes, and development of cockpit procedures. Proposed design changes were evaluated and either incorporated in the XV-15 design, modified, or discarded,

based on simulation results. The many hours of piloted operation of the simulator provided valuable training before flying this unconventional aircraft from one mode to the other. The intermediate, or tilt, modes were also investigated thoroughly. A major accomplishment of this extensive simulation activity was that there were no significant surprises to the pilots in flight, and that they were comfortable with the aircraft. The similarities of the simulation to actual flight, commented upon from the beginning, enhanced safety during the flight test program. In most cases, simulation limitations (to be discussed) made the aircraft easier to fly than the simulator.

As the test program progressed, the simulation model was updated to reflect flight-test data. Control-systems refinements were evaluated on the simulator before they were incorporated into the XV-15 design. These refinements, primarily to the rpm governor and SCAS, improved the response and handling qualities of the aircraft. Flight-test anomalies, real or predicted, were investigated, and in many cases resolved through the use of the simulation model.

In addition to the simulation activities directly related to flight test and configuration development, limited investigations were made of the XV-15's potential for military missions.

#### Problem Areas

A consistent problem with the XV-15 piloted simulation evaluations was height control in hovering flight. Initially, the problem was severe and caused vertical pilot-induced oscillations (PIO). This complicated vertical landing tasks, and, at times, the simulated aircraft could not be successfully landed. Part of the problem was identified as visual system time-constant errors and motion system washouts; although improvements were made, the problem was not completely resolved. Engine and power-lever (collective) responses were then improved by reducing the engine time-constant and providing some lead in vertical response to power-lever inputs. Considerable improvement in height control resulted. This PIO tendency is normally not encountered by the pilots in the actual aircraft; however it is identifiable on time history data. In hovering flight, most of the power-lever activity occurs within a foot or two of the ground because of downwash perturbations.

An apparent low roll damping caused many simulator pilots to induce low-frequency (about .5 Hz), low-magnitude roll oscillations in hovering flight. This tendency has been seen only to a slight degree in the aircraft. A roll SCAS limit cycle can be observed on strip-chart recorders during flight; however, most pilots are not aware of the oscillation. On the simulator it was common, and the PIO was distracting. A detailed evaluation of the roll dissimilarities between the aircraft and simulator was performed and is discussed in the section on fidelity.

Airspeed limits were imposed on XV-15 FSAA simulator operations because of numerical instabilities or computer cycle time effects. Generally, the simulator airspeed limit occurred at 230-240 KIAS and was manifested by the start of a low-magnitude, moderate-frequency pitch oscillation. This could be avoided by operating with the pitch SCAS off. In fixed base operation, it could not be seen by the pilot, but it was still occurring. These limits will affect higher speed XV-15 simulation investigations until cycle times are decreased. To date, the XV-15 has achieved 225 KIAS or 235 KCAS in level flight; the dive-speed envelope has not been investigated.

#### Limitations

As with any single-monitor television display, the field of view (FOV) available to the pilot was limited. For the FSAA, this field was 47° laterally by 37° vertically. The FOV from the pilot's seat (right side of cockpit) is shown in Fig. 16 along with that of the simulator. The limitations are obvious. In an attempt to improve the FOV over the nose, the viewpoint was biased 4° down. Some pilots perceived this as a slight nose-down attitude and corrected it with small, aft stick input.

This caused a tendency to inadvertently start low-velocity, aft translations in hover.

The lack of all peripheral cues prevented some military missions from being evaluated. Shipboard operation was an example of this limitation. A straight-in approach to the hangar deck on the stern of a Spruance-class destroyer (DD963) could be made; however, 45° or sliding approaches to an LHA were not possible. Once on the deck of the destroyer, the hangar door filled the entire FOV, and attitude control was very difficult, especially in hovering flight with the deck motion for various sea states. The field of view was not as significant a problem when operating on an LHA, but deck-motion problems were similar. This is primarily a software problem in establishing aircraft contact with a moving deck.

The largest visual system terrain board used provides a flyable length of 13.2 km (8.2 miles) and a width of 2.7 km (1.7 miles). When pilots exceed these limits, they encounter a simulated cloud bank, and must go on instruments. This occasionally caused orientation problems, particularly during high-speed operations; however, the pilots generally adapted fairly quickly to this limitation. For extended cruise flight or evaluations without terrain board limitations, the camera could be placed in a "tub" which provided a 360° scene above the clouds, with distant clouds and sky for attitude reference. The loss of visual translation cues in this environment was not as significant to the pilot.

#### Future Applications

To date, only limited evaluations of advanced tilt-rotor applications,<sup>12</sup> other than those related to the project, have been conducted at Ames Research

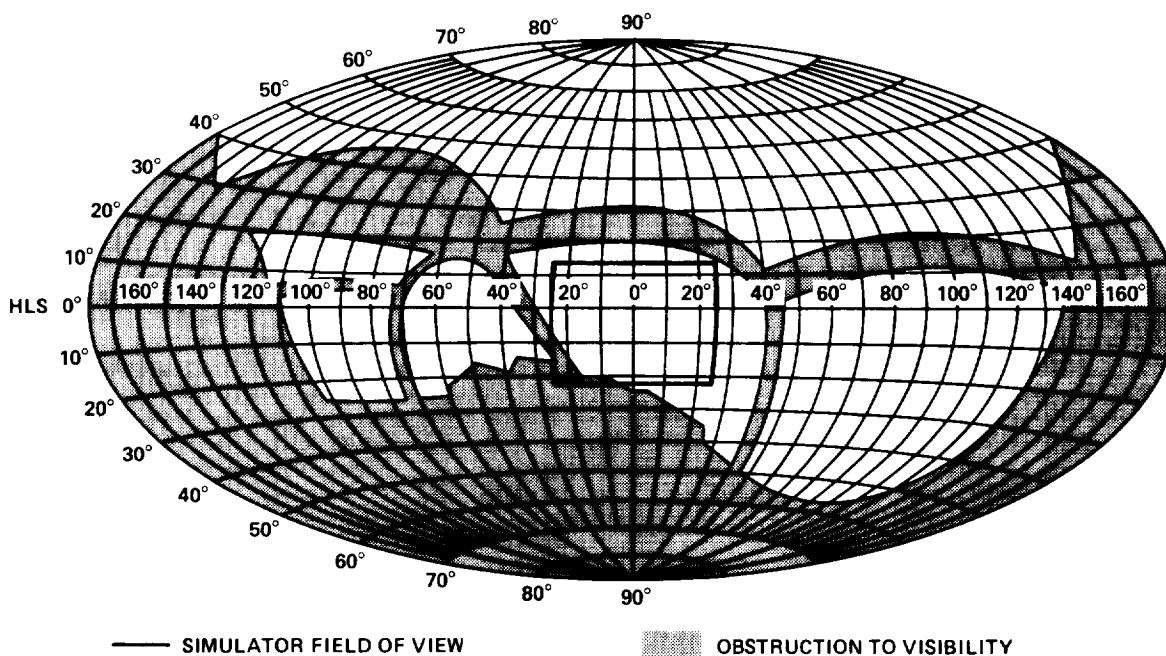

Fig. 16 XV-15 pilot seat field of view.

Center using the XV-15 simulation model. However, the military services are interested in the tilt-rotor concept for application to military missions, based on the demonstrated ability to perform the mission of a helicopter and that of a high-speed, turboprop airplane. The versatility of the concept is enhanced by its low noise signature, rapid acceleration/deceleration, and fuel efficiency.

Service demonstrations of the XV-15 are scheduled this year. These include the concept's evaluation for the Army's Special Electronic Mission Aircraft (SEMA), operations in a shipboard environment for the U.S. Marines/U.S. Navy, and operation in the nap-of-the-earth (NOE) environment. Some preliminary evaluations of these missions have been performed on the simulator. The simulation model also has the capability to permit investigations of growth versions of tilt-rotor configurations which meet military service requirements of the future. Scaled-up tilt rotors of the 35,000-lb class are being considered. In addition to military versions, the application of tilt-rotor technology to civil missions has been studied. Simulation offers an early look at certification criteria, both VFR and IFR, for this unique concept.

Additional areas where this existing simulation capability will be of significant value are in advanced control-system developmental work. These include sophisticated control-law formulations for alleviation of structural loads problems in maneuvers (rotor flapping controller), and in development of fly-by-wire/optics systems.

#### Simulation Fidelity

An assessment of simulation fidelity necessarily remains subjective from the pilot's viewpoint, although specific recommendations for assessment in terms of objective measures are beginning to appear.<sup>14-17</sup> Regardless of assessment technique, any specific determination of fidelity is tempered by the purpose of the simulation and the tasks to be performed. Good fidelity is assured if the simulation-generated cues cause the simulator task to specifically relate to the real-world task or if that which the pilot experiences and learns in the simulator adequately prepares him for the actual aircraft experience. Sinacori<sup>14</sup> defines fidelity in two ways: engineering fidelity, meaning the measured closeness to the real world; and perceptual fidelity, meaning the perceived closeness to the real world. Good perceptual fidelity is obtained when the pilot gets out of the simulator saying, "That is the airplane." If the simulation engineering staff can fully corroborate or rationalize the basis for the pilot either making or not making this statement, then both fidelity categories are defined. The following discussions present the major fidelity issues encountered during the various XV-15 simulations, and the steps taken to improve the perceptual fidelity, without compromising the engineering fidelity.

#### Digital Cycle-Time Effects

In any digital simulation program, a prime item affecting the simulation fidelity is the cycle time--the time increment from digital computer read-in to system response as seen by the pilot. For example, if the pilot inputs a control

displacement, the increment enters the digital computer at the first read-in point, the data are processed during the time interval, and the response is returned to the pilot an average of 1.5 cycles after his inputs. This shows up as a discrete time delay, essentially giving the pilot an apparent adverse phase shift, with no gain change. If the pilot is providing a control input at 0.5 Hz, the phase lag increment is  $-18^\circ$  for a 67-msec cycle time. This is a simplistic view of this effect. The significant point is that if an aircraft system is marginal on response, such that a pilot-induced oscillation (PIO) tendency exists, the cycle-time delay can make it critical. Also, if cycle times become large, there is the possibility of the pilot being aware of the digital updates through a "ratchet"-type effect in perceived visual system responses. Based on these problems, it is desirable to maintain the cycle time as low as possible, preferably less than 40 msec.

Because of the size and complexity of the XV-15 mathematical model, the cycle times have always been in excess of 50 msec, and during recent experiments, as high as 70 msec. This long cycle-time contributed to three specifically identified simulation problems: a roll-control PIO problem at low airspeeds in helicopter-mode flight; a vertical-mode PIO tendency at low airspeeds; and a high-air-speed numerical instability in the pitch axis, with the stability and control augmentation system (SCAS) engaged. It also required a compromise in the landing gear modeling.

Roll PIO Problems. The roll PIO problem was most severe with the most recent simulation efforts, when the cycle-time approached 70 msec. This was due to increased sophistication of the simulation to include ship dynamics for carrier compatibility evaluations, and this was also the first time measured aircraft control hysteresis was used extensively during routine evaluations. The problem was further aggravated by a change made in the visual system drive parameters which caused an unexplained additional lag, not detected during the setup period, and also, not present in prior simulations. During this simulation period, the aircraft was also in flight test, enabling specific test data to be obtained to investigate the discrepancy between flight and simulator characteristics. These data are presented in Fig. 17 as the simple roll degree-of-freedom frequency response characteristics in hover.

The first step in developing the data shown in Fig. 17 was to calculate the rigid airframe-controls response characteristics, using perturbation derivatives obtained from the simulation. This was considered valid, since flight checks of aircraft control sensitivity (roll rate per inch control) showed good agreement with simulation results. The aircraft response-time constants were not determined. The aircraft oscillatory response data were then obtained at frequencies of 4.5 and 6.6 rad/sec, and compared with the simulator response (without hysteresis); the gross discrepancy in both the aircraft and simulator phase relative to the calculated rigid airframe phase was then found. The aircraft discrepancy was resolved by incorporating the known control flexibility,\* which had been documented

\*Churchill, Gary B., Clement, Warren F., and Craig, Samuel J., "XV-15 Tilt Rotor Aircraft Control Systems Status Report," Tilt Rotor Research Aircraft Project Office, NASA, ARC, Moffett Field, Calif.



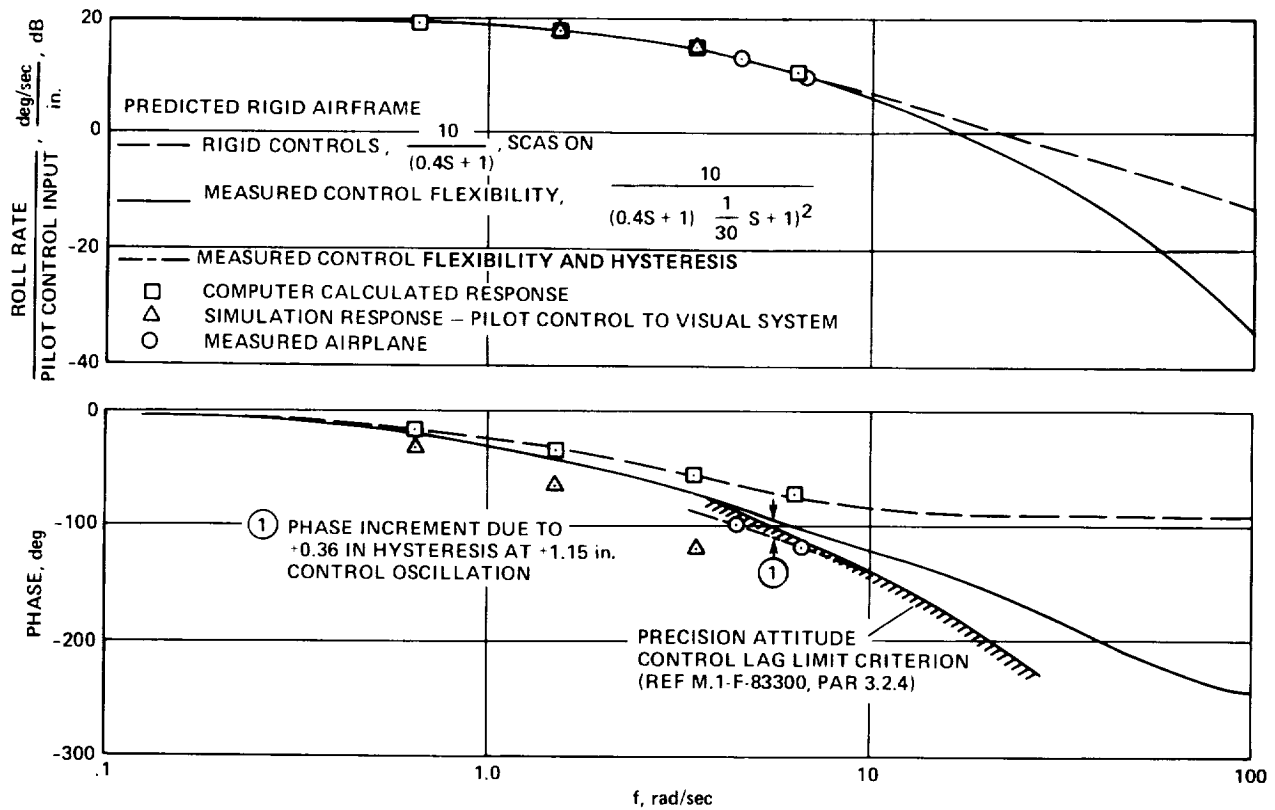

Fig. 17 XV-15 hover roll response: aircraft versus simulation, attitude retention off.

during the aircraft control-system integrated systems tests, and adjusting the phase for the effects of control hysteresis.<sup>18</sup> The gain increment predicted by Ref. 18 does not show in the aircraft response because of a unique SCAS design. This completely rationalized the aircraft discrepancy and, with the inclusion of the attitude control lag-limit criterion,<sup>19</sup> substantiated the aircraft PIO tendency. The basis for the simulator PIO characteristics was fully substantiated by the visual lag; however, the anticipated phase lag increment was 18° at 3 rad, not 63°, as measured.

The visual system roll axis normally has a 0.22-sec lead installed, which compensates for a smoothing filter installed to prevent the "ratchet" effect owing to cycle-time from being apparent to the pilot. This lead was increased to 0.45 sec; the effect of the lead is presented in Fig. 18. These data were obtained by driving the lateral stick trim position, with the attitude-retention SCAS mode engaged. The stick gradient was increased to attempt to prevent the stick from "breaking out" of trim, because of the motion, since this disengages attitude retention. This worked for the two low-frequency points, but not at frequencies above 2 rad/sec, and caused the amplitude response to be higher than predicted in this region. The effect of the 0.23-sec lead was to increase the response by 3 dB at 3 rad, and to bring the phase into very close agreement with predicted aircraft characteristics. (These shaping functions for altering the visual response characteristics are discussed in detail in Ref. 5.) For this configuration, then, the response closely approximated the aircraft with control flexibility, but with no hysteresis. Reference 20 provides an

excellent technical analysis of the importance of visual display lag effects and compensation. During these tests, the motion-system response was also evaluated; it showed reasonable correlation with the aircraft. The previously established phase for 0.22-sec lead is presented for comparison.

On the day following the implementation of this "fix," a pilot encountered the roll PIO in the aircraft, while on final approach. His comment during the postflight debriefing was, "You've fixed the simulation, now fix the . . . . airplane!" This work is in progress.

These data are unique, in that correlation data of this depth are rarely available. However, the requirement for perceptual fidelity to be corroborated by engineering fidelity evaluations is vividly demonstrated.

**Vertical PIO Problem.** The vertical-mode PIO problem was quite similar to the roll problem. The present aircraft thrust/power management system creates a slight PIO tendency on approach, which can be seen in flight data time histories. Pilots have excited this on occasion, but not for more than 3 to 4 cycles. As in the roll problem, when hysteresis was introduced in the simulation, all pilots had PIO problems. Even without the hysteresis, the simulator was always more critical. Investigation of the mathematical model showed the engine response-time constant to be high by a factor of 3 (1.8 sec instead of 0.6), based on engine-test-stand data provided by Lycoming. One additional problem was found by checking visual system vertical-drive errors, and finding a drive-system lag which was unrelated to cycle time. This combined with the

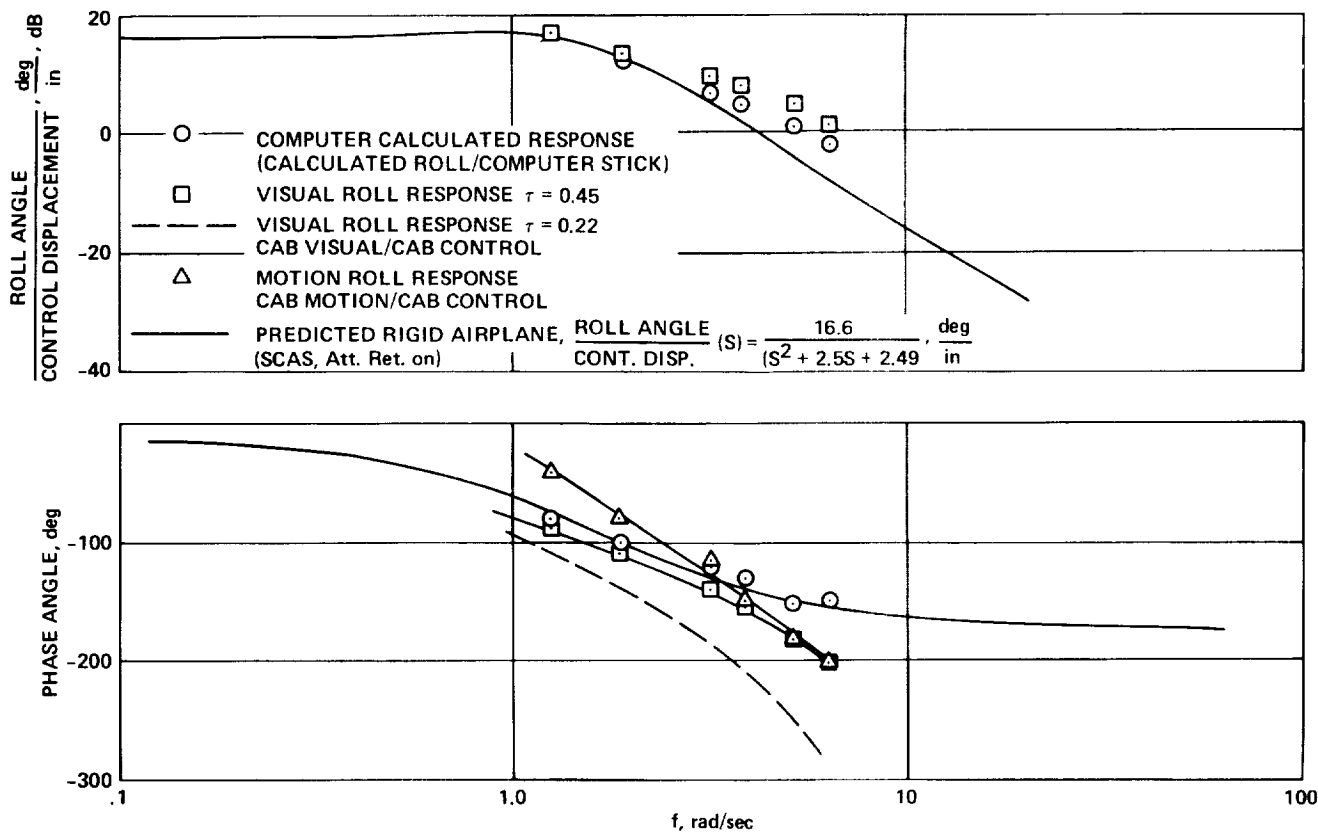

Fig. 18 XV-15 simulator roll response.

digital cycle-time delay to give a total system delay of about 0.2 sec at about 3 rad/sec. Resolving the vertical response problem then required elimination of the hysteresis and adding lead compensation in the visual vertical drive to eliminate the drive error. System design changes to alleviate the actual aircraft PIO tendency are presently being evaluated, and will be incorporated in March 1982. This problem was less severe on the VMS than on the FSAA, indicating that it may be partially caused by vertical motion cueing. Sufficient specific fidelity evaluations to rationalize this have not been obtained.

Numerical Instability. The numerical instability at high speeds, SCAS on, results from a numerical instability in the pitch SCAS transfer function integration algorithm caused by cycle-time delays. Several fixes have been attempted; all were minimally effective. The net effect is a large-amplitude, high-frequency, pitch limit-cycle that occurs at about 240 knots at cycle times of about 60 msec, and at 190 knots at a cycle time of 70 msec. The divergence airspeed appears to be approximately an inverse function of the cycle-time. Since the primary use of the simulation has been at lower airspeeds, further resolution of this problem has not been attempted.

Landing Gear. The final element of the simulation significantly affected by digital cycle-times is the landing gear modeling. Reasonable simulation cycle-times for landing gear modeling are of the order of 2 to 4 msec because of the extremely high rate of change of landing gear loads during touchdown. The XV-15 cycle-time

requirements therefore precluded using an accurate model; however, a simplified model was developed which reasonably represented the touchdown and roll-out characteristics. This modeling is adequate for gross evaluations of taxi and ground handling. The modeling of the gear is invalid at simulated power settings of less than 20% where numerical instabilities occur.

#### Simulator Hardware Effects

The simulation hardware affecting the dynamics of simulation fidelity are the flight controls, the motion and associated washout systems, and the visual systems. These systems critically affect the fidelity in all phases of operation, occasionally in subtle, unanticipated ways. At the onset of the simulation program, it was determined that specific, definitive criteria and methods for evaluating simulation fidelity, as affected by these systems, were lacking. Systems Technology, Inc. was, therefore, asked to provide these<sup>21</sup> under the ongoing support services contract for the XV-15.

The procedures developed by STI defined the performance data requirements and criteria for initial evaluations, as well as suggested periodic checks to be made against possible degradations owing to "wear and tear." A summary of the significant checks and evaluation criteria is presented in Fig. 19. The visual system performance checks were added by the tilt-rotor Project Office in 1981, following the previously discussed roll PIO problems. With the exception of the static alignment procedure for visual system setup, all fidelity check procedures have been automated to facilitate

SYSTEM	CHECK	PROCEDURE	NORMAL FREQUENCY
VISUAL	1. STATIC ALIGNMENT	1. TEMPLATE ALIGNMENT	DAILY
	2. LINEAR CALIBRATION	2. MAINTENANCE	WEEKLY
	3. DYNAMIC RESPONSE	3. SAFE*	WEEKLY
	4. PERFORMANCE	4. STRIP CHART RECORDING OF POSITION ERRORS DURING NORMAL OPERATIONS	DAILY
MOTION	1. DYNAMIC RESPONSE WASHOUT PROGRAM IN/OUT	1. SAFE*	WEEKLY
	2. THRESHOLD/SMOOTHNESS	2. AUTOMATED MOTION CHECK	DAILY
CONTROL LOADERS	1. GRADIENT, BREAKOUT FUNCTION	1. X-Y PLOTS OF FORCE vs DISPLACEMENT	SETUP
	2. DYNAMIC RESPONSE	2. SAFE*	SETUP

\*SIX AXIS FREQUENCY EVALUATION

Fig. 19 Simulation hardware fidelity evaluations.

their use in the event such use is warranted by suspected malfunctions.

Visual System. The capability to perform fidelity checks quickly and easily is of particular importance with the visual systems. These may be used as much as 16 hr per day on a variety of simulations, with only weekly maintenance, unless specific faults are identified. The static alignment procedure is performed during set-up at the beginning of a shift. This is normally sufficient, but if the simulated aircraft requires a low pilot-eye height in the runway, the alignment must be repeated several times during the day (because of temperature effects on the structure supporting the terrain boards and the camera gantry). The linear calibrations and the dynamic response of the system using the SAFE\* procedure are normally not variant, and the weekly checks during maintenance should be sufficient.

The overall performance checks, added in September 1981, were found to be the most important during operations. These were done using the full-up simulation, and performing relatively severe low-altitude, low-speed maneuvers, which included lateral and longitudinal quick stops, jump takeoffs, and hard landings. The time-history plots of the visual-system errors gave an immediate presentation of any system problems, such as degraded servo performance, or hysteresis and threshold problems. It was found that this procedure was at times more effective in locating system malfunctions than the normal maintenance procedures.

Motion System. In general, the motion system performances on both the FSAA and the VMS were consistent during simulation periods. The daily motion checks adequately verified overall

\*SAFE-Six-Axis Frequency Evaluation—is a program originally designed to measure the frequency response of the motion base. It has also been adapted to use on the visual systems and McFadden loader systems.

performance, and the weekly SAFE runs provided complete software and computer equipment verifications. The only significant deficiency is the lack of a capability of evaluating the motion drive and wash-out logic systems and making direct comparisons with calculated aircraft responses. As with most simulator motion systems, the determination of washout characteristics is somewhat of a "black art," and adequate cab instrumentation (linear and angular accelerometers or rate gyros) have not been available for specific determination of cab-to-aircraft response transfer function. The motion-drive logic parameters are set up by a "simulation" pilot operating the system before it is given to "real" pilots. This occasionally requires iterations, especially if the simulation is of a real aircraft, such as the XV-15.

Control Loaders. McFadden control loaders were provided for the control sticks and pedals, and they were found to be quite reliable in all simulations. The data for force versus displacement and frequency responses were spot checked periodically and did not change.

Flight-Test Data Correlation

The final test of both engineering and perceptual fidelity comes with comparison of simulation and flight-test results. To date, the scope of the XV-15 flight-test program has included envelope expansion and aeroelastic stability testing. This has provided significant amounts of performance and trim data. Handling qualities have been evaluated only qualitatively; however, some dynamics data have been obtained for evaluation of specific aircraft anomalies.

Performance. Level-flight predicted and measured performance data are presented in Fig. 20. The only change in the simulation program to generate the predicted data was to increase the flat plate drag from 7 to 9 ft<sup>2</sup>. This increment was based on the XV-15 wind-tunnel tests performed in 1978.

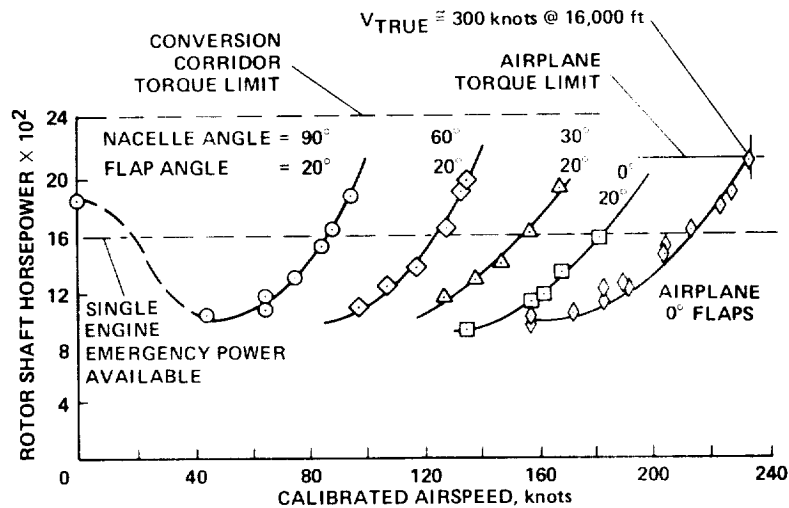

Fig. 20 XV-15 Level-flight performance.

**Static Trim.** The static longitudinal trim curves are presented in Fig. 21 as functions of airspeed and nacelle incidence angle,  $i_N$ . Correlation is generally good, with the deviation between prediction and test increasing as the aircraft is converted from the helicopter to airplane mode. This is attributable to errors in modeling of the downwash at the tail. The simulation model is based on small-scale wind-tunnel data, and two minor discrepancies exist: one is caused by flap effects, the other by wind-tunnel wall effects. The downwash discrepancy between prediction and flight data at 160 knots, with flaps retracted, is approximately 1°.

**Dynamics.** The real essence of simulation fidelity is in obtaining good correlation on system dynamics: pilot responses, disturbance responses, and stability problems. The specific handling-qualities issues have not yet been addressed in the flight-test program, so comparative data are generally not available. Qualitative evaluations of short period, dutch roll, and maneuver characteristics have not indicated significant disparities between the aircraft and the simulation. Hover control responses in pitch, roll, and yaw with SCAS modifications were evaluated, and control sensitivities in flight were very close to design values established on the simulator. The roll axis dynamic response data obtained for the fidelity checks also bear this out. There were, however, two additional simulation fidelity checkpoints flown where specific comparative data were obtained, and one instance of flight instability predicted on the simulator.

The flight-stability problem, caused by the rpm governor, occurs at high sink rate (2,500 ft/min) and at about 70 knots airspeed. It is characterized by large-amplitude rotor-speed, pitch-attitude, and sink-rate oscillations. When

first encountered on the simulator (1975), the pilots would consistently either crash or abort. The recovery procedure defined was simply to increase power. The instability was first encountered on the aircraft during the first high-sink-rate approaches in 1979. Governor time-history data from this flight and from the simulation are presented in Fig. 22. The decay of the oscillation occurs in both cases after power application. This governor instability problem has since been fully resolved, using a simulation defined modification to the governor. It was not resolved when discovered on the simulation, because the contractor did not believe it was "real"; however, the Project Office thought it was real, and a safe, effective recovery mode was defined. Flight safety was the only basis under the terms of the contract on which the Project Office could force design changes.

The two additional flight checks for fidelity data were flown because the pilots believed that the simulator trim change with flaps and trim change with power in airplane mode were excessive. This was during a period when the simulation was operating simultaneously with XV-15 flight-test operations at Ames Research Center, and the flight-test plan included airplane-mode operations. These data, presented in Figs. 23 and 24, show good correlation between the aircraft and simulator. In these instances the engineering fidelity is shown to be quite good; before flight checks, however, the perceptual fidelity was regarded as poor. The reason for this is not fully understood; however, it does point out the value of flying specific maneuvers on both the simulator and aircraft for fidelity comparisons. A rationale may be that the limited acceleration capability in the simulator biases the perceptual fidelity. The net result is that this contributes to the tendency of the pilots to treat the actual aircraft much more tenderly than they do the simulator.

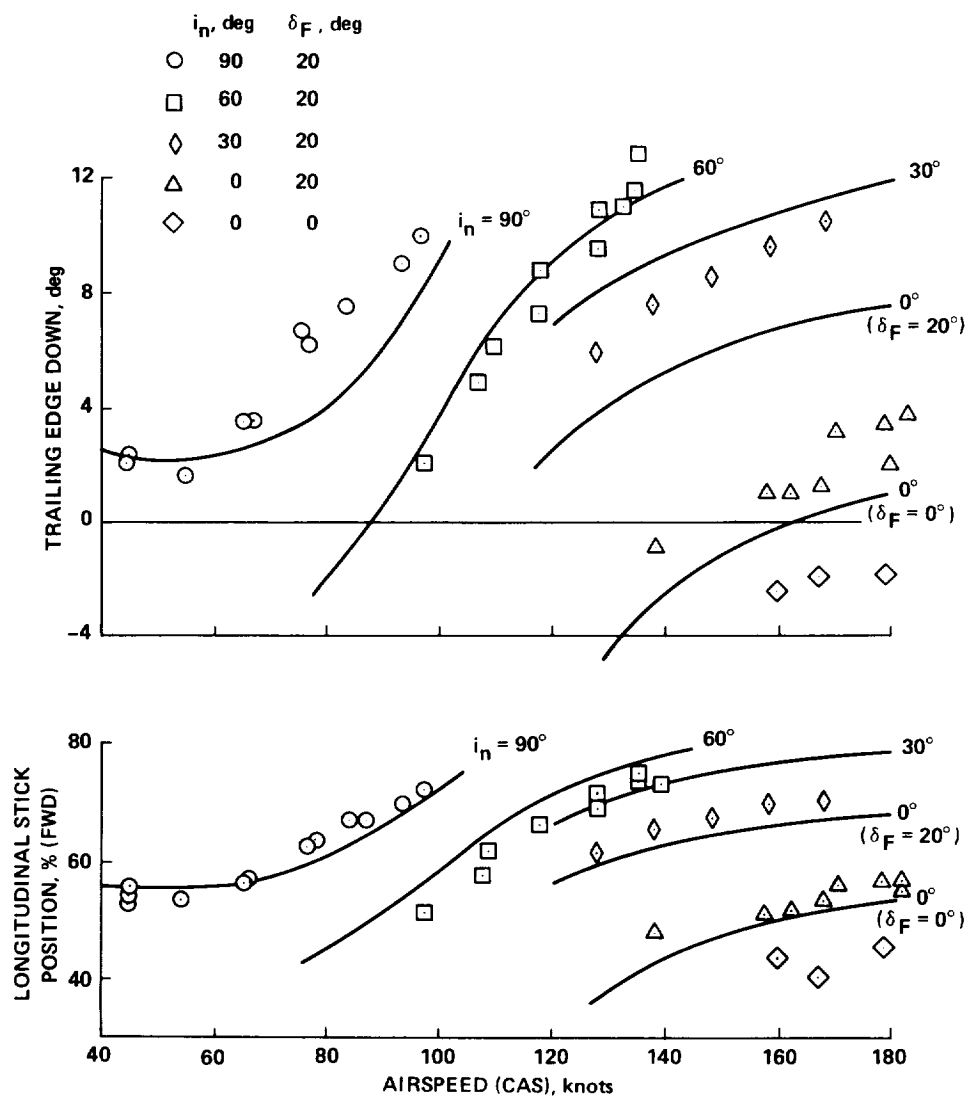

Fig. 21 XV-15 Longitudinal control versus airspeed.

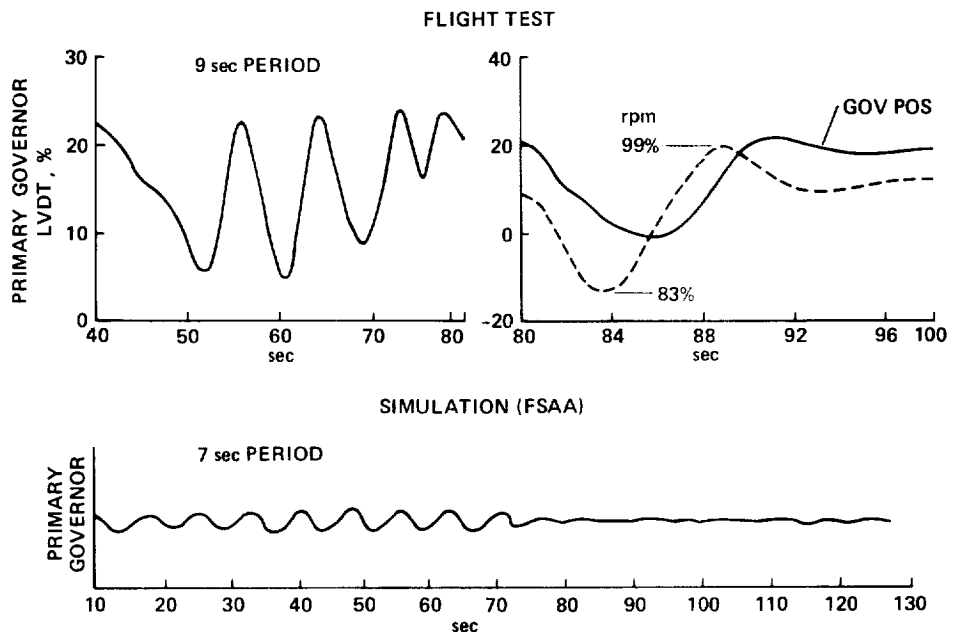

Fig. 22 Governor instability-time history comparisons.

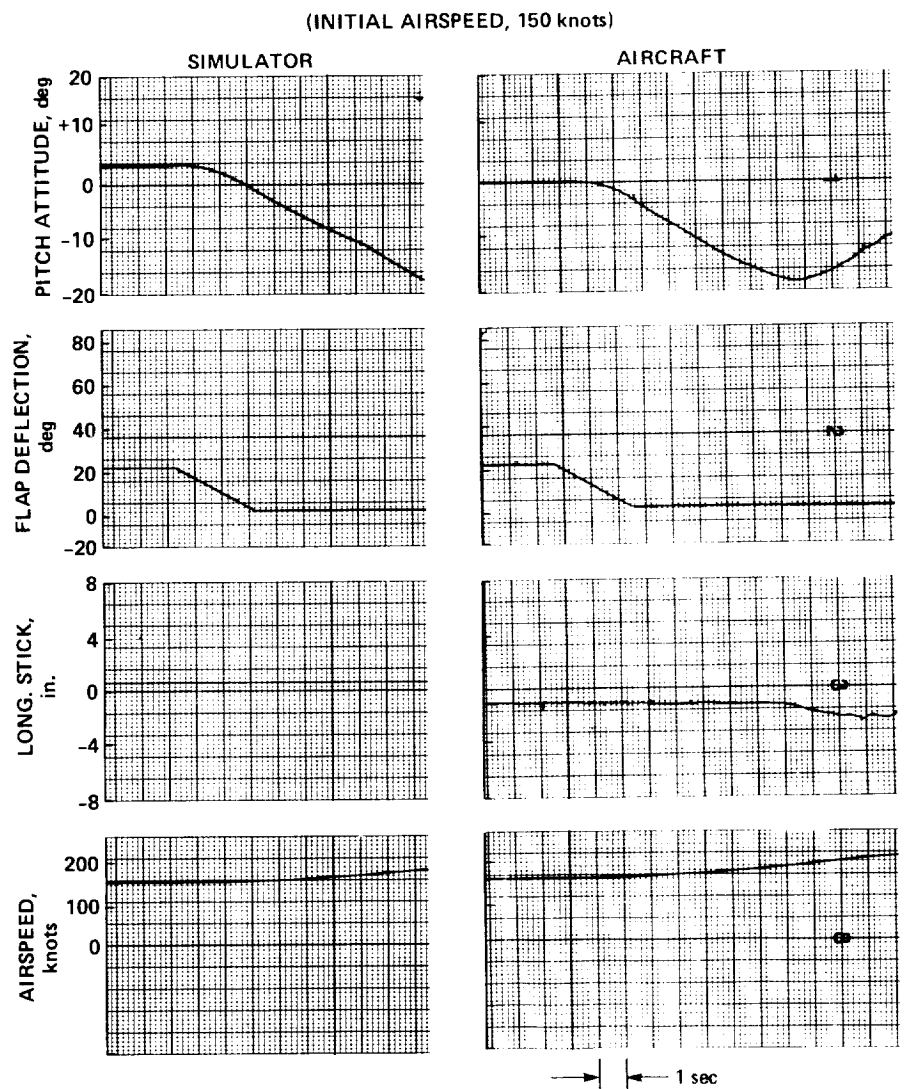

Fig. 23 Simulator versus aircraft: trim change with flap retraction (initial airspeed 150 knots).

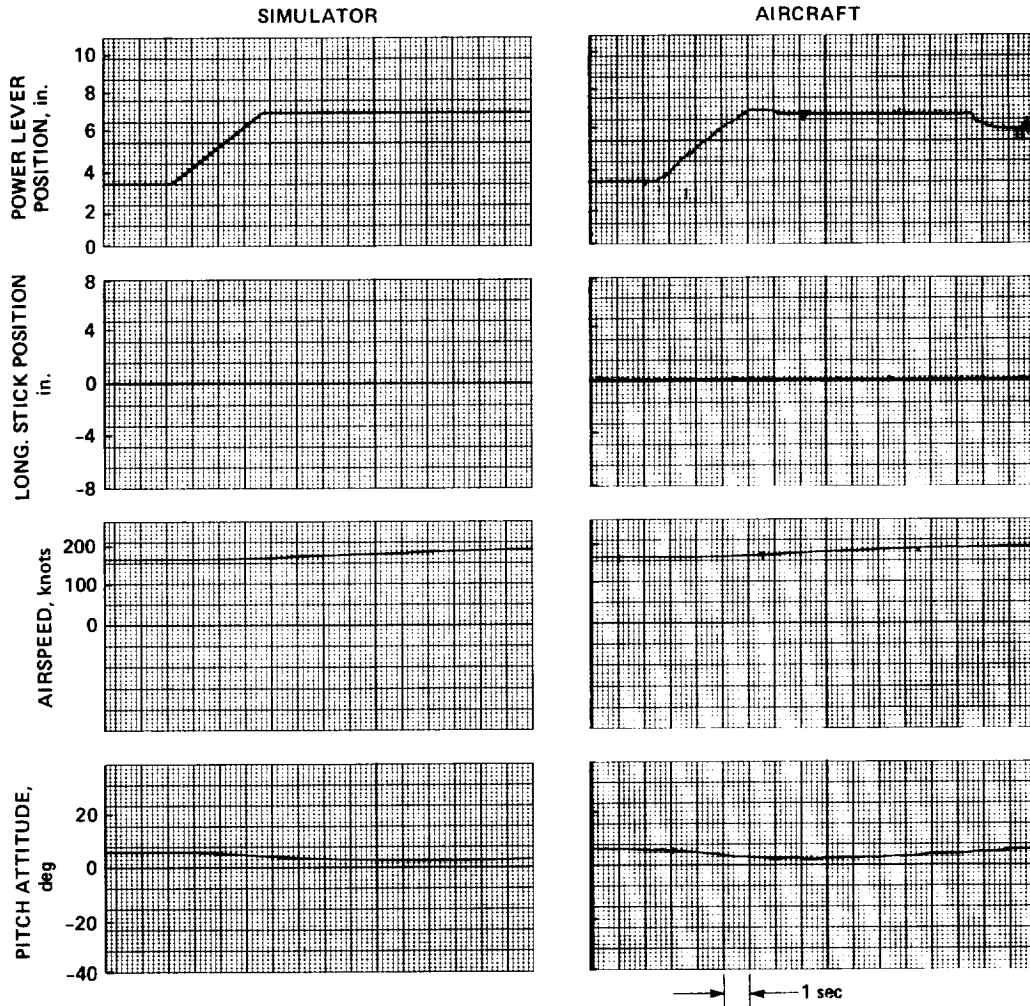

Fig. 24 Simulator versus aircraft: trim change with power pull (initial airspeed 163 knots).

#### Conclusions

The following conclusions derive from the XV-15 Tilt Rotor Research Aircraft simulations studies:

1) Simulation has been a powerful tool in procurement, design, development, and flight test of the XV-15 tilt-rotor aircraft.

2) A requirement for simulation during proposal evaluations provides major benefits to the procuring agency.

3) Perceptual fidelity evaluations of simulation are invalid without engineering corroborations.

4) Engineering fidelity evaluations require full equipment dynamic response evaluations, as well as evaluations of the mathematical model.

5) Use of simulation for developing specification or certification criteria is invalid without first evaluating the simulation fidelity.

6) Fidelity evaluation procedures and criteria are the most significant deficiencies in this "art."

7) As a result of simulation fidelity evaluations, a potentially critical aircraft roll PIO problem was identified.

All of this simulation effort—although it accomplished specific objectives in XV-15 design, evaluation, and pilot training—had another significant effect on the program: this was the confidence of the pilots and engineers in the design and handling qualities of the aircraft. The XV-15 continues to safely demonstrate tilt-rotor technology for military and civil applications.

### References

- <sup>1</sup>Maisel, Martin D., et al., "NASA/Army XV-15 Tilt Rotor Research Aircraft Familiarization Document." NASA TM X-62,407, 1975
- <sup>2</sup>Marr, R. L., Willis, J. M., and Churchill, G. B., "Flight Control System Development for the XV-15 Tilt Rotor Aircraft," presented at the 32nd Annual National Forum of the American Helicopter Society, Washington, D.C., May 1976.
- <sup>3</sup>Dugan, D. C., Erhart, R. G., and Schroers, L. G., "The XV-15 Tilt Rotor Research Aircraft," NASA TM-81244 (AVRADCOM Technical Report 80-A-15), 1980.
- <sup>4</sup>"XV-15 Flight Manual," TP-78-XV-15-1, Bell Helicopter Textron, Aug. 15, 1980.
- <sup>5</sup>Sinacori, John B., Stapleford, Robert L., Jewell, Wayne F., and Lehman, John M., "Researchers Guide to the NASA Ames Flight Simulator for Advanced Aircraft (FSAA)," NASA CR-2875, 1975.
- <sup>6</sup>Harenda, P. B., Joglekar, M. J., Gaffey, T. M., and Marr, R. L., "A Mathematical Model for Real-Time Flight Simulation of the XV-15 Tilt Rotor Research Aircraft," NASA CR-114614 (release pending final report approval), 1982.
- <sup>7</sup>Marr, Roger L., and Roderick, W. E. B., "Handling Qualities Evaluation of the XV-15 Tilt Rotor Aircraft," presented at the 30th Annual National Forum of the American Helicopter Society, Washington, D.C., May 1974.
- <sup>8</sup>Ringland, Robert F., and Craig, Samuel J., "Simulated Limit Cycle Behavior in the Collective Control Linkage of the XV-15 Aircraft," Working Paper 1048-11, Systems Technology, Inc., Hawthorne, Calif., Nov. 1975.
- <sup>9</sup>Marr, R. L., "XV-15 Flight Simulator Period No. 1 (FSAA Simulator, December 1973), "prepared under Contract No. NAS2-7800 by Bell Helicopter Textron, Feb. 13, 1974.
- <sup>10</sup>Marr, R. L., "XV-15 Flight Simulator Period No. 2 (FSAA Simulator, July 1974), "prepared under Contract No. NAS2-7800 by Bell Helicopter Textron, Aug. 30, 1974.
- <sup>11</sup>Marr, R. L., "XV-15 Flight Simulator Period No. 3 (FSAA Simulator, September 1975), "prepared under Contract No. NAS2-7800 by Bell Helicopter Textron, Jan. 13, 1976.
- <sup>12</sup>Brigadier, William L., "Analysis of Control Actuator Authority Requirements for Attitude and Translational Rate Command Augmentation Systems for the XV-15 Tilt Rotor Research Aircraft," NASA TM-81,243, 1980 (AVRADCOM Technical Report TR-80-A-13, Dec. 1980).
- <sup>13</sup>Hall, W. E., "Preliminary Flight Test Planning for XV-15 Tilt Rotor Aircraft," NASA CR-152392, 1979.
- <sup>14</sup>Sinacori, John B., "Piloted Aircraft Simulation Concepts and Overview," Technical Report 1074-2, Systems Technology, Inc., Hawthorne, Calif., (prepared under NASA Contract NAS2-9024) Mar. 1978.
- <sup>15</sup>"Fidelity of Simulation for Pilot Training," edited by David L. Key, AGARD Advisory Report No. 159, Oct. 1980.
- <sup>16</sup>NASA Ad Hoc Advisory Subcommittee, Avionics, Control and Human Factors, 1980.
- <sup>17</sup>Heffley, Robert K., Clement, Warren F., et al., "Determination of Motion and Visual System Requirements for Flight Training Simulators," Technical Report No. 1162-1, Systems Technology, Inc., Hawthorne, Calif., Aug. 1981 (forthcoming Army Research Institute report).
- <sup>18</sup>Graham, Dunstan, and McRuer, Duane, Analysis of Nonlinear Control Systems, Dover Publications, Inc., 1971.
- <sup>19</sup>"Flying Qualities of Piloted V/STOL Aircraft," MI-L-F-83300, 31 Dec. 1970.
- <sup>20</sup>Crane, D. Francis, "Flight Simulator Visual Display Delay Compensation," presented at Winter Simulation Conference, Atlanta, Ga., Dec. 9-11, 1981.
- <sup>21</sup>Craig, S. J., "Data Requirements for Simulation Fidelity Assurance," Working Paper No. 1048-1, Systems Technology, Inc., Hawthorne, Calif. (prepared under NASA Contract No. NAS2-8025) June 1974.



1. Report No. NASA TM-84222 AVRADCOM Tech.Rep.82-A-4		2. Government Accession No.		3. Recipient's Catalog No.	
4. Title and Subtitle SIMULATION OF THE XV-15 TILT ROTOR RESEARCH AIRCRAFT				5. Report Date March 1982	
				6. Performing Organization Code	
7. Author(s) Gary B. Churchill and Daniel C. Dugan				8. Performing Organization Report No. A-8848	
				10. Work Unit No. 532-04-11	
9. Performing Organization Name and Address Ames Research Center, NASA, and AVRADCOM Research and Technology Laboratories, Moffett Field, CA 94035				11. Contract or Grant No.	
				13. Type of Report and Period Covered Technical Memorandum	
12. Sponsoring Agency Name and Address National Aeronautics and Space Administration, Washington, D.C. 20546, and U.S. Army Aviation Research and Development Command, St. Louis, Missouri 63166				14. Sponsoring Agency Code	
				15. Supplementary Notes Point of Contact: Gary B. Churchill, Ames Research Center, Mail Stop 237-5, Moffett Field, CA (415) 965-6091 or FTS 448-6091	
16. Abstract <p>The XV-15 Tilt Rotor Research Aircraft Program (TRRA) exemplifies the effective use of simulation from issuance of the request for proposal through conduct of a flight test program. From program inception, simulation complemented all phases of XV-15 development. The initial simulation evaluations during the source evaluation board proceedings contributed significantly to performance and stability and control evaluations. Eight subsequent simulation periods provided major contributions in the areas of control concepts; cockpit configuration; handling qualities; pilot workload; failure effects and recovery procedures; and flight boundary problems and recovery procedures. The fidelity of the simulation also made it a valuable pilot training aid, as well as a suitable tool for military and civil mission evaluations. Recent simulation periods have provided valuable design data for refinement of automatic flight control systems. Throughout the program, fidelity has been a prime issue and has resulted in unique data and methods for fidelity evaluation which are presented and discussed.</p>					
17. Key Words (Suggested by Author(s)) Simulation Fidelity Tiltrotor Pilot-Induced Oscillation			18. Distribution Statement  Unlimited Star Category 05		
19. Security Classif. (of this report) Unclassified		20. Security Classif. (of this page) Unclassified		21. No. of Pages 23	22. Price* A02

